

REV.	REVISION DESCRIPTION	DATE	CKD.

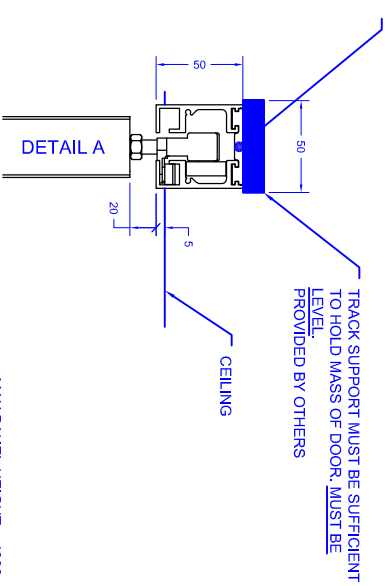

MAX PANEL HEIGHT = 4000mm  
MIDRALL REQUIRED OVER 3000mm  
MAX PANEL WIDTH = 800mm  
MAX PANEL WEIGHT  
SUPPORT BY CARRIERS = 60KG  
MAX NUMBER OF PANELS = UNLIMITED  
RESTRICTED BY ALLOCATED CUPBOARD SPACE

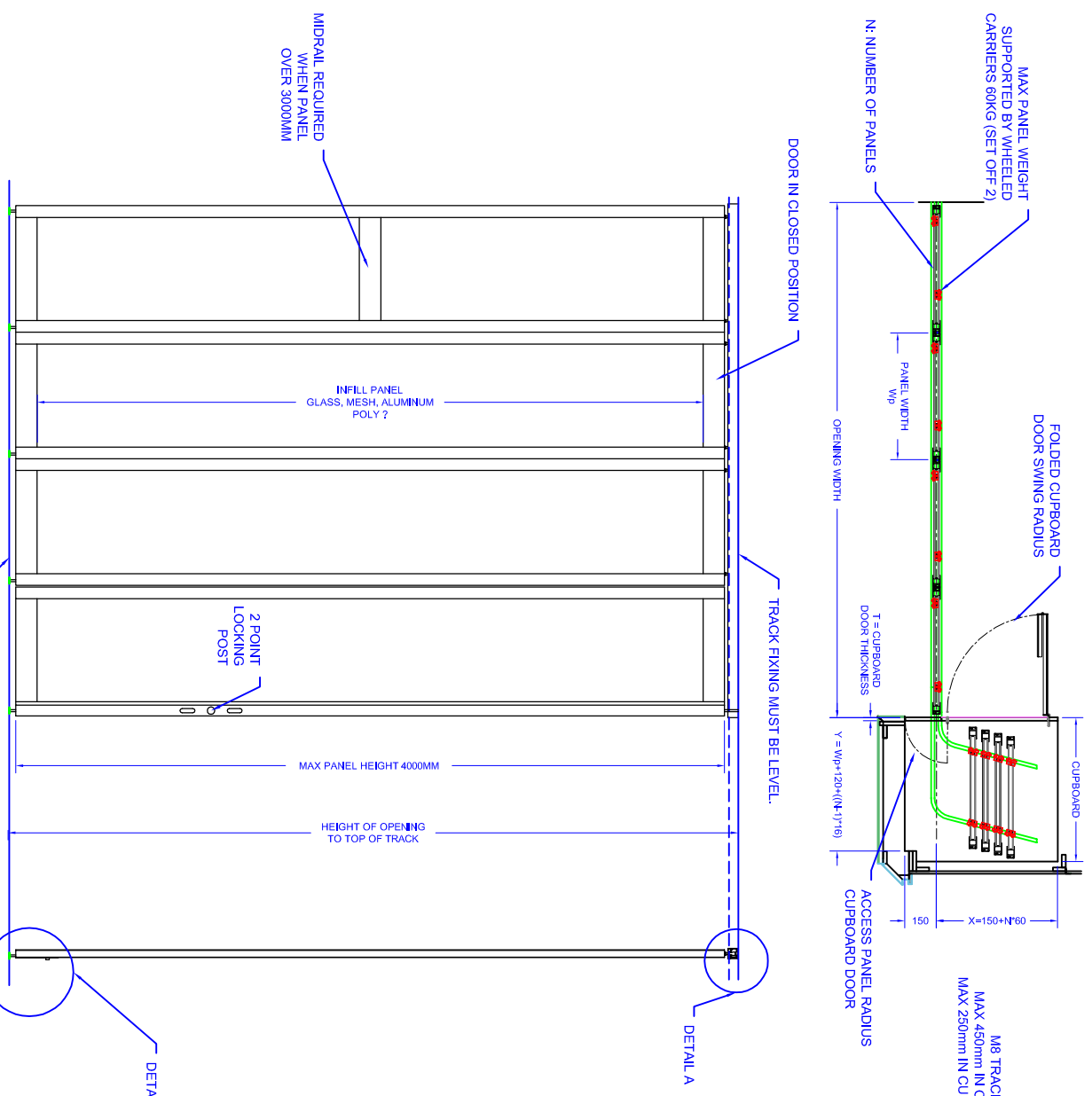
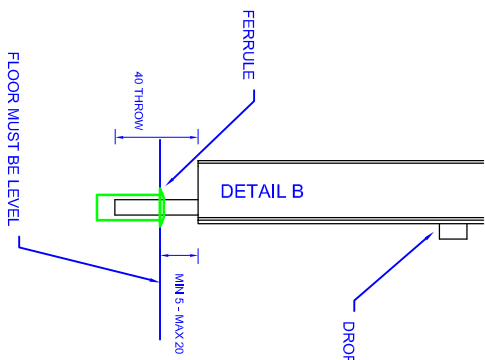

FOR GUARANTEED OPENING,  
REQUIRED TOLERANCES:  
WIDTH = -0mm / +5mm  
HEIGHT = -0mm / +5mm

"FOR FURTHER INFORMATION CONTACT  
MIRAGE ENGINEERING STAFF"

U.O.S. DIMENSIONS IN MILLIMETRES

**CONFIDENTIAL NOTE:** This drawing and its designs, specifications and engineering information disclosed hereon are the property of Mirage Doors (Aust) Pty Ltd and are not to be disseminated or reproduced without express written consent. The drawing is loaned in confidence and then only for consideration of the matter disclosed hereon. In accepting loan of this drawing, the recipient agrees to keep it and the matter disclosed hereon in confidence and not to use nor permit their use in any way detrimental to Mirage Doors (Aust) Pty Ltd.

<b>Mirage Doors (Aust) Pty Ltd</b>		PROJECT	Fiesta
ACN 601 182 629	PH 1 800 465 599	STACKING DOORS	
DATE 08/03/2016	DRAWN J.R.	CHECKED	NTS
APPROVED & DATE	SCALE	TITLE	PARALLEL STACK
FILE FILENAME.dwg	SIZE A3	DRAWING NO. QLD-	REV. 0
			SHEET 1/2

REV.	REVISION DESCRIPTION	DATE	CHKD.

MAX PANEL HEIGHT = 4000mm  
 MIDRAIL REQUIRED OVER 3000mm  
 MAX PANEL WIDTH = 8000mm  
 MAX PANEL WEIGHT  
 SUPPORT BY CARRIERS = 60Kg

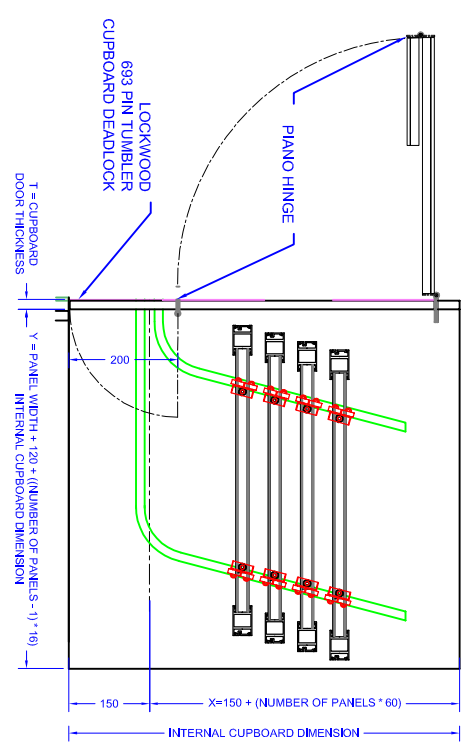
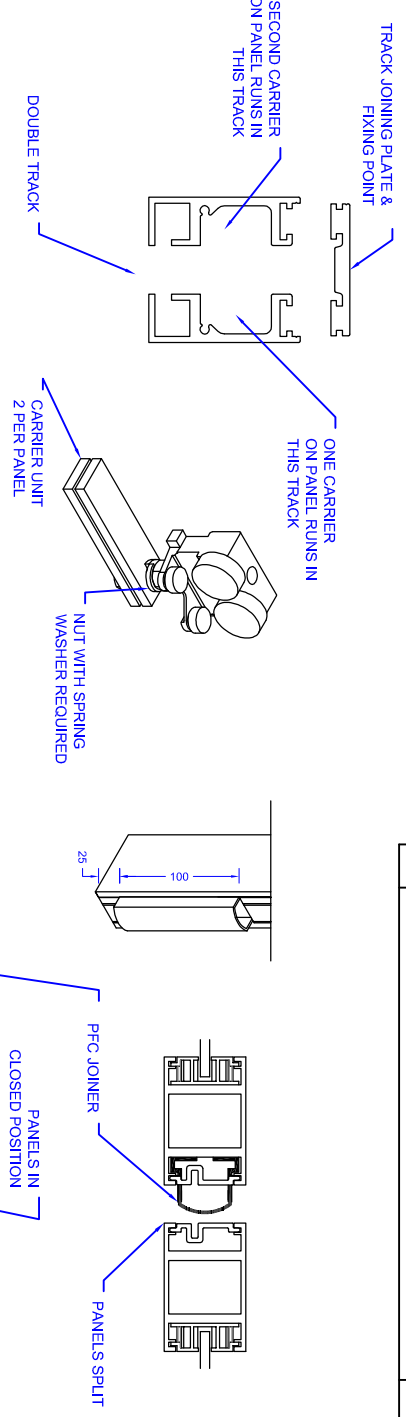

CUPBOARD DETAIL VIEW - INTERNAL CLEAR SIZES

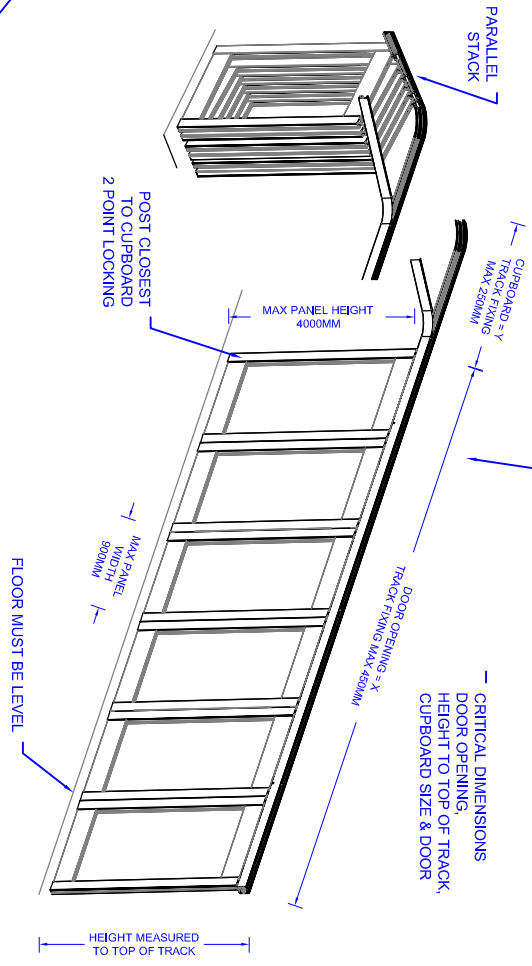
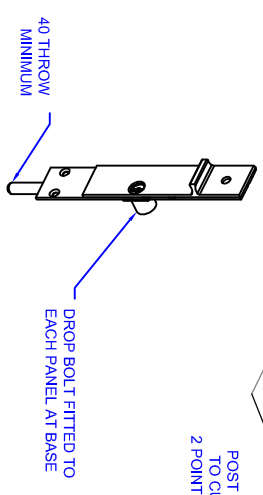

"FOR FURTHER INFORMATION CONTACT  
 MIRAGE ENGINEERING STAFF"

U.O.S. DIMENSIONS IN MILLIMETRES

CONFIDENTIAL NOTE: This drawing and its designs, specifications and engineering information disclosed herein are the property of Mirage Doors (Aust) Pty Ltd and are not to be disseminated or reproduced without express written consent. The drawing is loaned in confidence and then only for consideration of the matter disclosed herein. In accepting loan of this drawing, the recipient agrees to keep it and the matter disclosed herein in confidence and not to use nor permit their use in any way detrimental to Mirage Doors (Aust) Pty Ltd.

<b>Mirage Doors (Aust) Pty Ltd</b>		PROJECT: FIESTA	
ACN 601 182 629	PH 1 800 465 599	STACKING DOORS	
DATE 08/03/2016	DRAWN J.R.	DETAILS	
SCALE NTS	CHECKED	DRAWING NO.	
FILE FILENAME.dwg	SIZE A3	REV. 0	SHEET 2/2