

REV.	REVISION DESCRIPTION	DATE	CKD.

***FOR FURTHER INFORMATION CONTACT
MIRAGE ENGINEERING STAFF***

MAX PANEL HEIGHT = 3000mm
 MAX PANEL WIDTH = 750mm
 MAX PANEL WEIGHT = 40kg
 MAX NO OF PANELS IN ONE DIRECTION
 CENTRE = 15

FOR GUARANTEED OPENING,
 REQUIRED TOLERANCES:
 WIDTH = -0mm / +5mm
 HEIGHT = -0mm / +5mm

TRACK SUPPORT MUST BE
 SUFFICIENT TO HOLD MASS OF
 DOOR, MUST BE LEVEL,
 PROVIDED BY OTHERS

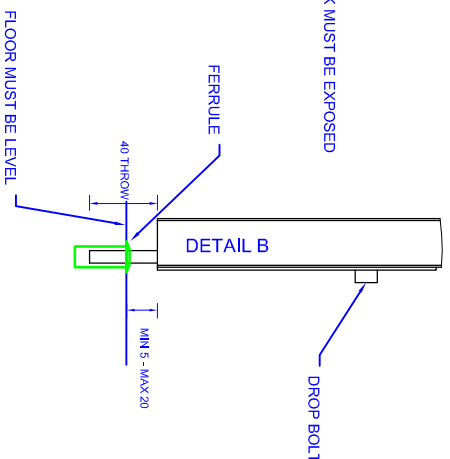
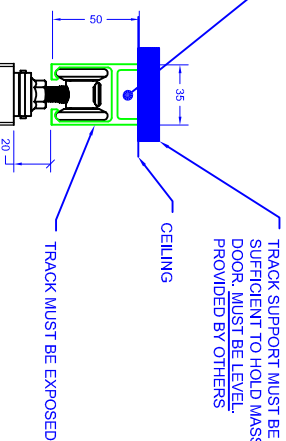
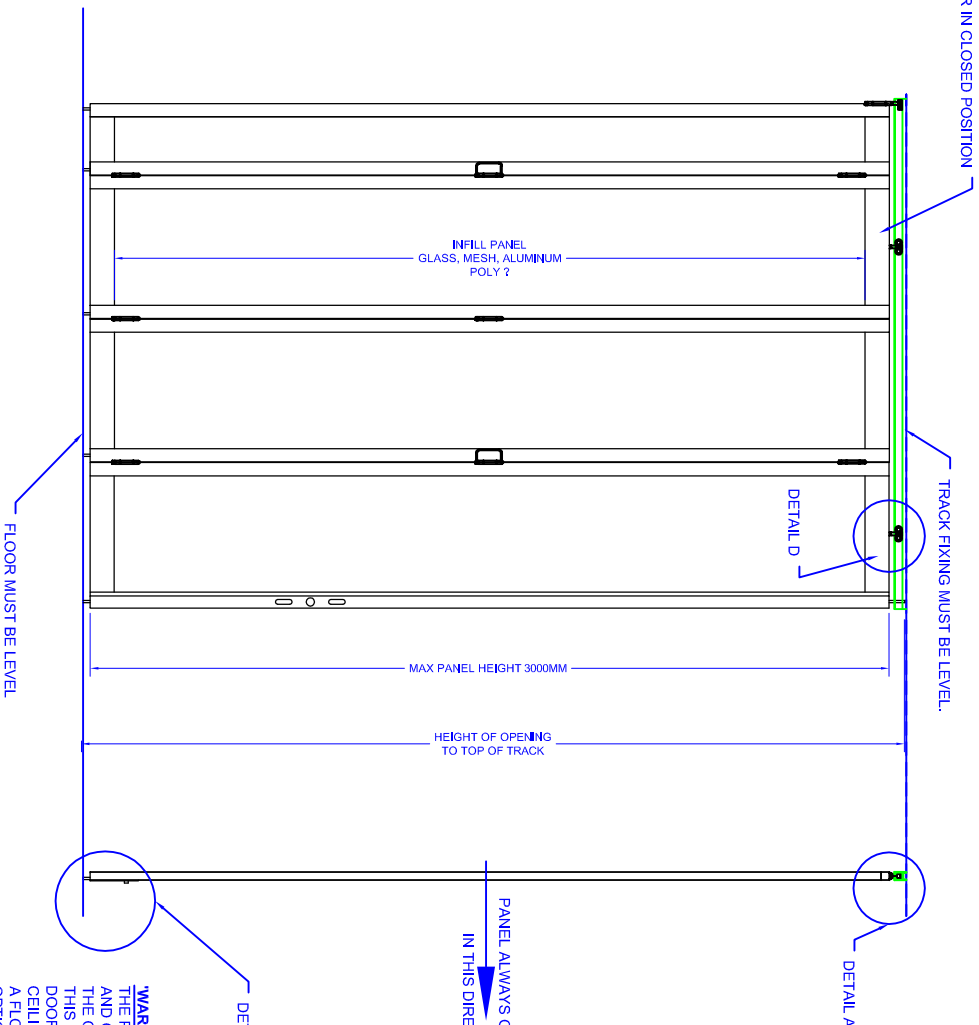
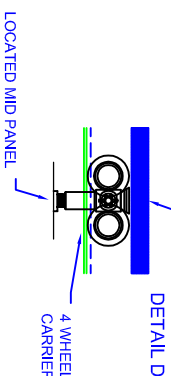

WARNING - THIS DOOR CONFIGURATION HAS THE POTENTIAL TO SWING DURING OPENING AND CLOSING PROCESSES DEPENDING ON THE CARE AND HANDLING BY THE OPERATOR. THIS SWINGING MOTION MAY CAUSE THE DOOR PANELS TO HIT AND DAMAGE THE CEILING AND FLOOR FINISHES. TO AVOID THIS A FLOOR TRACK CAN BE PROVIDED AS AN OPTIONAL EXTRA. MIRAGE DOORS WILL NOT BE RESPONSIBLE FOR DAMAGE CAUSED BY POOR OPERATION OF THE PRODUCTS.

U.S. DIMENSIONS IN MILLIMETRES
 CONFIDENTIAL NOTE: This drawing and its designs, specifications and engineering information disclosed hereon are the property of Mirage Doors (AUST) PTY LTD and are not to be disseminated or reproduced without express written consent. The drawing is loaned in confidence and then only for consideration of the matter disclosed hereon. In accepting loan of this drawing, the recipient agrees to keep it and the matter disclosed hereon in confidence and not to use nor permit their use in any way detrimental to Mirage Doors (AUST) PTY LTD.

Mirage Doors (Aust) Pty Ltd		PROJECT	
ACN 601 182 629	PH 1 800 465 599	FIESTA	
DATE 08/03/2016	SCALE NTS	FOLDING DOORS	
DRAWN J.R.	CHECKED	CENTRE HUNG FOLDING	
APPROVED & DATE		SIZE A3	DRAWING NO. QLD-
FILE FILENAME.dwg		REV. 0	SHEET 1/3

REV.	REVISION DESCRIPTION	DATE	CHKD.

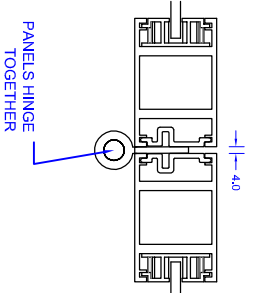
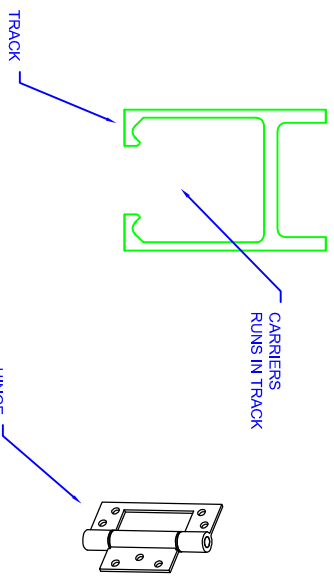
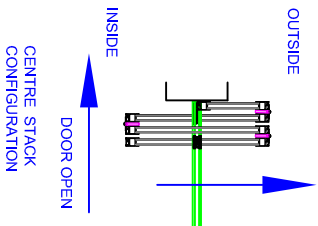

MAX PANEL HEIGHT = 3000mm
 MAX PANEL WIDTH = 750mm
 MAX PANEL WEIGHT = 40Kg
 MAX NO OF PANELS IN ONE DIRECTION
 INTERNAL = 8 FORWARD = 10

WARNING: THIS DOOR CONFIGURATION HAS THE POTENTIAL TO SWING DURING OPENING AND CLOSING PROCESSES DEPENDING ON THE CARE AND HANDLING BY THE OPERATOR. THIS SWINGING MOTION MAY CAUSE THE DOOR PANELS TO HIT AND DAMAGE THE CEILING AND FLOOR FINISHES. TO AVOID THIS A FLOOR TRACK CAN BE PROVIDED AS AN OPTIONAL EXTRA. MIRAGE DOORS WILL NOT BE RESPONSIBLE FOR DAMAGE CAUSED BY POOR OPERATION OF THE PRODUCTS.

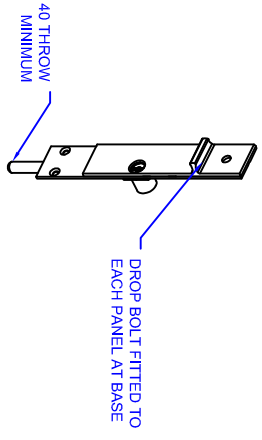
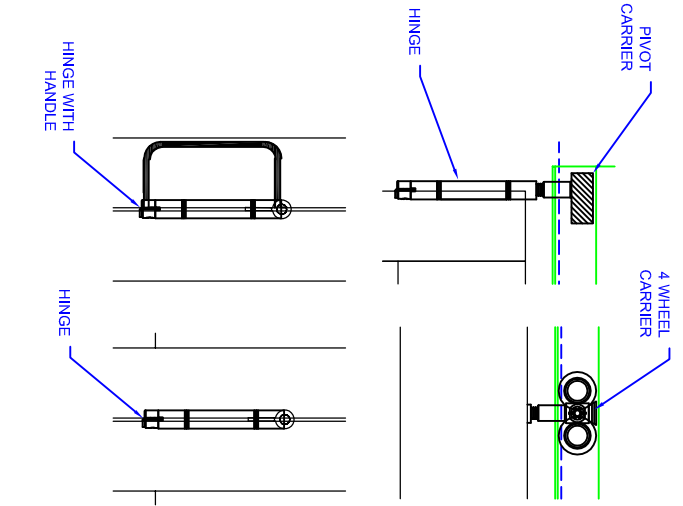

CRITICAL DIMENSIONS
 DOOR OPENING HEIGHT TO TOP OF TRACK.

10G x 50mm TRACK FIXING
 MAX 200mm IN OPENING
 MAX 75mm @ STACK ENDS

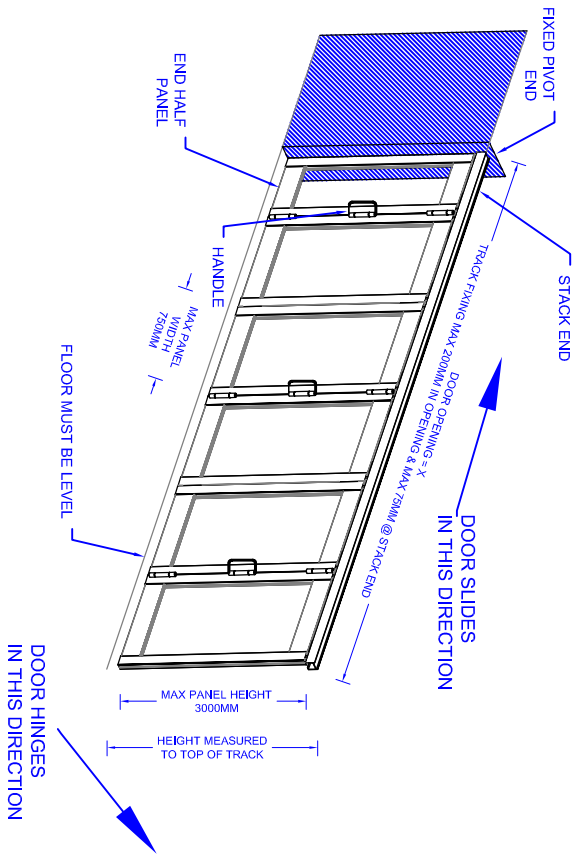

**"FOR FURTHER INFORMATION CONTACT
 MIRAGE ENGINEERING STAFF"**

U.O.S. DIMENSIONS IN MILLIMETRES
 CONFIDENTIAL NOTE: This drawing and its designs, specifications and engineering information disclosed hereon are the property of Mirage Doors (Aust) Pty Ltd and are not to be disseminated or reproduced without express written consent. The drawing is loaned in confidence and then only for consideration of the matter disclosed hereon. In accepting loan of this drawing, the recipient agrees to keep it and the matter disclosed hereon in confidence and not to use nor permit their use in any way detrimental to Mirage Doors (Aust) Pty Ltd.

Mirage Doors (Aust) Pty Ltd		PROJECT Fiesta	
ACN 601 182 629		FOLDING DOORS	
PH 1 800 465 599		CENTRE HUNG FOLDING	
DATE 08/03/2016	SCALE NTS	TITLE DETAILS	
DRAWN J.R.	CHECKED	SIZE A3	REV. SHEET 0 2/3
APPROVED & DATE		DRAWING NO.	
FILE FILENAME.dwg		QLD-	

REV.	REVISION DESCRIPTION	DATE	CKD.

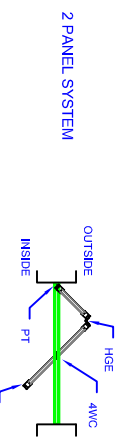
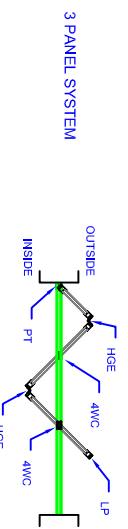
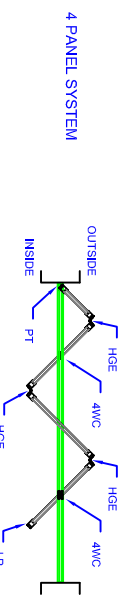
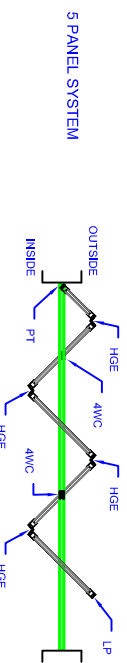
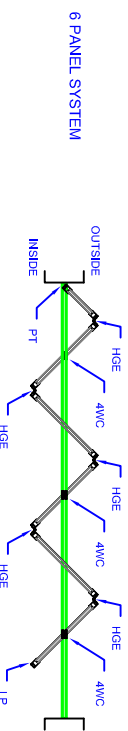
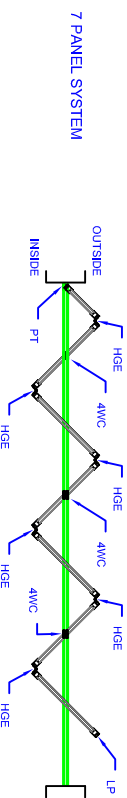
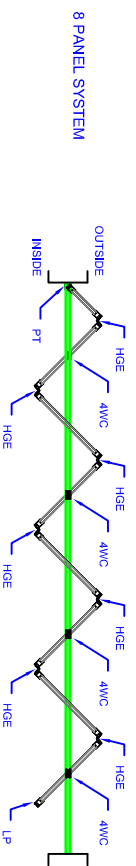

LP - LOCKING POST
PT - PIVOT POINT - FIXED END
HGE - HINGE LOCATION
4WC - 4 WHEEL CARRIER

U.O.S. DIMENSIONS IN MILLIMETRES

CONFIDENTIAL NOTE: This drawing and its designs, specifications and engineering information disclosed hereon are the property of Mirage Doors (Aust) Pty Ltd and are not to be disseminated or reproduced without express written consent. The drawing is loaned in confidence and then only for consideration of the matter disclosed hereon. In accepting loan of this drawing, the recipient agrees to keep it and the matter disclosed hereon in confidence and not to use nor permit their use in any way detrimental to Mirage Doors (Aust) Pty Ltd.

Mirage Doors (Aust) Pty Ltd		PROJECT	
ACN 601 182 629	PH 1 800 465 599	FIESTA	
DATE 08/03/2016	SCALE NTS	FOLDING DOORS	
DRAWN J.R.	CHECKED	CENTRE HUNG FOLDING	
APPROVED & DATE		LAYOUT CONFIGURATIONS	
FILE FILENAME.dwg		SIZE A3	REV. SHEET 0 3/3